



3-terminal filters

Feedthrough filter for power line

YFF-P series

YFF15PC	1005 [0402 inch]*	Feed through filter
YFF18PC	1608 [0603 inch]*	Feed through filter
YFF18PH	1608 [0603 inch]*	Feed through filter (thickness: 0.8mm)
YFF18PW	1608 [0603 inch]*	Feedthrough filter (low ESL type)
YFF21PC	2012 [0805 inch]*	Feed through filter
YFF31PC	3216 [1206 inch]*	Feed through filter

* Dimensions Code JIS[EIA]

3-terminal filters

Product compatible with RoHS directive
Compatible with lead-free solders

Feedthrough filter for power line

Overview of the YFF-P series

FEATURES

- Small and high-performance EMC components.
- Good attenuation characteristic in a wide band range.
- For large current (2A to 4A) applications.

APPLICATION

For the power line of communication terminal devices, such as a smart phone, and AV and information devices.

PART NUMBER CONSTRUCTION

Series name	L x W dimensions		Product internal code		Rated voltage		Capacitance		Tolerance	Taping	TDK internal code	Reel size		Internal electrode Ni
	Code	mm			Code	V	Code	pF				Code	mm	
YFF	15	1.0x0.5	PC	STD	0G	4	104	100,000	M	±20%		0	ø178	N
	18	1.6x0.8	PH	Thickness 0.8mm	0J	6.3	105	1,000,000 (1.0µF)				9	ø330	
	21	2.0x1.2	PW	low ESL	1A	10	435	4,300,000 (4.3µF)						
	31	3.2x1.6			1C	16	226	22,000,000 (22µF)						
					1E	25								

PACKAGING STYLE AND SPECIFICATIONS

Type	Package quantity (piece/reel)		Individual weight (g)
	ø178 (mm)	ø330 (mm)	
YFF15PC	10,000	50,000	0.0008
YFF15PC0G435M	10,000	50,000	0.0015
YFF15PC0G755M	10,000	50,000	0.0027
YFF15PC0G106M	10,000	50,000	0.0029
YFF18PC	4,000	10,000	0.0038
YFF18PH	4,000	10,000	0.0051
YFF18PW	4,000	10,000	0.0038
YFF21PC	4,000	10,000	0.0095
YFF31PC	2,000	10,000	0.0342

- RoHS Directive Compliant Product: See the following for more details. <https://product.tdk.com/info/en/environment/rohs/index.html>
- Halogen-free: indicates that Cl content is less than 900ppm, Br content is less than 900ppm, and that the total Cl and Br content is less than 1500ppm.

 Please be sure to request delivery specifications that provide further details on the features and specifications of the products for proper and safe use. Please note that the contents may change without any prior notice due to reasons such as upgrading.

Overview of the YFF-P series

RECOMMENDED SOLDERING CONDITION

REFLOW SOLDERING

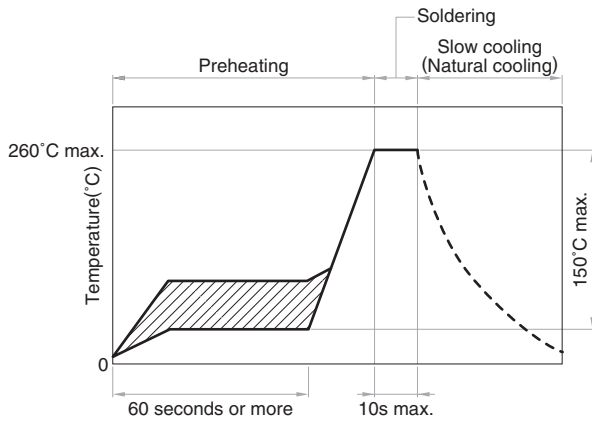

HAND SOLDERING

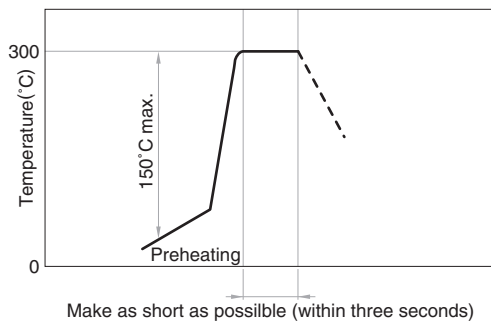

REMINDERS FOR USING THESE PRODUCTS

- Before soldering, be sure to preheat components. The ΔT preheating temperature must be 150°C max. with attention paid to thermal shock.
- Natural cooling of components in the air is recommended. On the other hand, when dipping them in a solvent for purposes, such as cleaning, make sure that the temperature difference (ΔT) is 100°C.
- When performing hand soldering for circuit modification, apply the soldering iron to the copper foil area of the printed circuit board for 3 seconds or less. The temperature of the iron tip should not exceed 300°C.
- Use a wrist band to discharge static electricity in your body through the grounding wire.
- When incorporating the printed circuit board on which this product is mounted into a frame, etc., do not apply stress to the product through local bending of the board by tightening of screws, etc.

YFF-P series **YFF15PC type**

■ SHAPE & DIMENSIONS

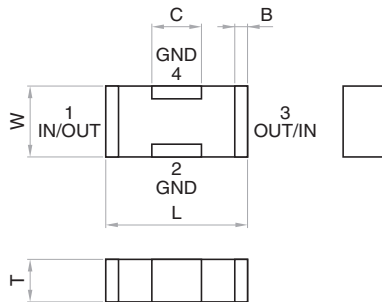

■ RECOMMENDED LAND PATTERN

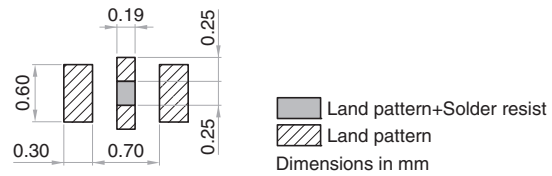

Part No.	L (mm)	W (mm)	T (mm)	B (mm)	C (mm)
YFF15PC0G106MT000N	1.00±0.20	0.50±0.20	0.50±0.15	0.07min.	0.35±0.10
YFF15PC0G106MT009N	1.00±0.20	0.50±0.20	0.50±0.15	0.07min.	0.35±0.10
YFF15PC0G755MT000N	1.00±0.20	0.50±0.15	0.50±0.15	0.07min.	0.35±0.10
YFF15PC0G755MT009N	1.00±0.20	0.50±0.15	0.50±0.15	0.07min.	0.35±0.10
YFF15PC0G435MT000N	1.05±0.05	0.65±0.05	0.45±0.05	0.09min.	0.30±0.10
YFF15PC0G435MT009N	1.05±0.05	0.65±0.05	0.45±0.05	0.09min.	0.30±0.10
YFF15PC0J105MT000N	1.05±0.05	0.65±0.05	0.45±0.05	0.09min.	0.30±0.10
YFF15PC0J105MT009N	1.05±0.05	0.65±0.05	0.45±0.05	0.09min.	0.30±0.10
YFF15PC0G105MT000N	1.00±0.05	0.55±0.05	0.30±0.05	0.09min.	0.30±0.10
YFF15PC0G105MT009N	1.00±0.05	0.55±0.05	0.30±0.05	0.09min.	0.30±0.10
YFF15PC0J474MT000N	1.00±0.05	0.55±0.05	0.30±0.05	0.09min.	0.30±0.10
YFF15PC0J474MT009N	1.00±0.05	0.55±0.05	0.30±0.05	0.09min.	0.30±0.10
YFF15PC1A224MT000N	1.00±0.05	0.55±0.05	0.30±0.05	0.09min.	0.30±0.10
YFF15PC1A224MT009N	1.00±0.05	0.55±0.05	0.30±0.05	0.09min.	0.30±0.10
YFF15PC1C104MT000N	1.00±0.05	0.55±0.05	0.30±0.05	0.09min.	0.30±0.10
YFF15PC1C104MT009N	1.00±0.05	0.55±0.05	0.30±0.05	0.09min.	0.30±0.10

* Make sure to connect the GND terminal of this product and the GND of the mounting circuit board by using through holes so that the distance between them is the shortest.

Background red: The product which is planning to stop production

■ ELECTRICAL CHARACTERISTICS

□ CHARACTERISTICS SPECIFICATION TABLE

Insertion loss 40dB frequency range (MHz)	Rated voltage Edc (V)	Rated current Idc (A)	Operating temperature range (°C)	Storage temperature range (After mount) (°C)	Part No.*
0.07 to 1000	4	2	-55 to +85	-55 to +85	YFF15PC0G106MT000N
0.07 to 1000	4	2	-55 to +85	-55 to +85	YFF15PC0G106MT009N
0.11 to 1000	4	2	-55 to +85	-55 to +85	YFF15PC0G755MT000N
0.11 to 1000	4	2	-55 to +85	-55 to +85	YFF15PC0G755MT009N
0.2 to 1000	4	2	-55 to +85	-55 to +85	YFF15PC0G435MT000N
0.2 to 1000	4	2	-55 to +85	-55 to +85	YFF15PC0G435MT009N
0.8 to 1000	4	3	-55 to +105	-55 to +105	YFF15PC0J105MT000N
0.8 to 1000	4	3	-55 to +105	-55 to +105	YFF15PC0J105MT009N
0.8 to 1000	4	3	-55 to +105	-55 to +105	YFF15PC0G105MT000N
0.8 to 1000	4	3	-55 to +105	-55 to +105	YFF15PC0G105MT009N
2 to 1000	6.3	3	-55 to +105	-55 to +105	YFF15PC0J474MT000N
2 to 1000	6.3	3	-55 to +105	-55 to +105	YFF15PC0J474MT009N
4 to 1000	10	3	-55 to +105	-55 to +105	YFF15PC1A224MT000N
4 to 1000	10	3	-55 to +105	-55 to +105	YFF15PC1A224MT009N
9 to 1000	16	3	-55 to +105	-55 to +105	YFF15PC1C104MT000N
9 to 1000	16	3	-55 to +105	-55 to +105	YFF15PC1C104MT009N

* The part numbers are TDK's standard specification products.

Background red: The product which is planning to stop production

⚠ Please be sure to request delivery specifications that provide further details on the features and specifications of the products for proper and safe use.
Please note that the contents may change without any prior notice due to reasons such as upgrading.

YFF-P series YFF15PC type

ELECTRICAL CHARACTERISTICS GRAPH

INSERTION LOSS VS. FREQUENCY CHARACTERISTICS

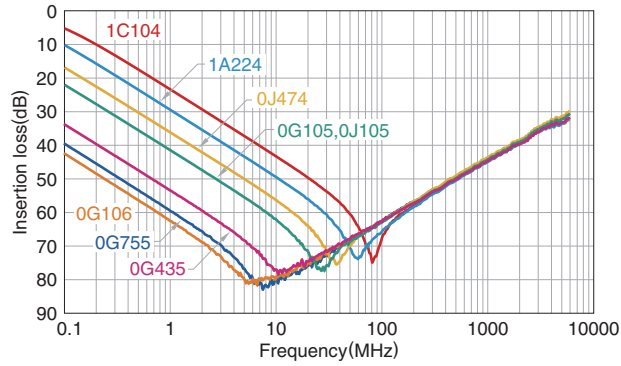

RATED CURRENT VS. TEMPERATURE CHARACTERISTICS (DERATING)

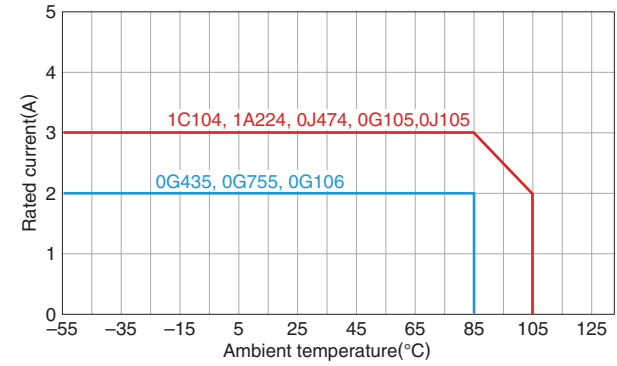

 Please be sure to request delivery specifications that provide further details on the features and specifications of the products for proper and safe use. Please note that the contents may change without any prior notice due to reasons such as upgrading.

YFF-P series YFF18PC type

SHAPE & DIMENSIONS

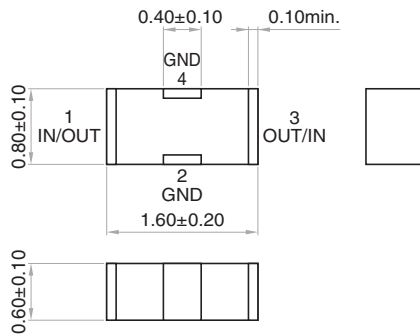

RECOMMENDED LAND PATTERN

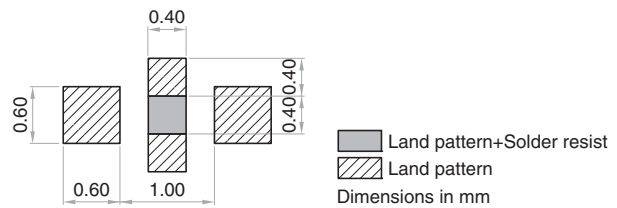

* Make sure to connect the GND terminal of this product and the GND of the mounting circuit board by using through holes so that the distance between them is the shortest.

ELECTRICAL CHARACTERISTICS

CHARACTERISTICS SPECIFICATION TABLE

Insertion loss 40dB frequency range (MHz)	Rated voltage Edc (V)	Rated current Idc (A)	Operating temperature range (°C)	Storage temperature range (After mount) (°C)	Part No.*
0.2 to 1000	6.3	4	-55 to +85	-55 to +85	YFF18PC0J475MT0H0N
0.2 to 1000	6.3	4	-55 to +85	-55 to +85	YFF18PC0J475MT0H9N
0.8 to 1000	6.3	4	-55 to +105	-55 to +105	YFF18PC0J105MT0H0N
0.8 to 1000	6.3	4	-55 to +105	-55 to +105	YFF18PC0J105MT0H9N
2 to 1000	6.3	4	-55 to +125	-55 to +125	YFF18PC0J474MT0H0N
2 to 1000	6.3	4	-55 to +125	-55 to +125	YFF18PC0J474MT0H9N
3 to 1000	6.3	4	-55 to +125	-55 to +125	YFF18PC0J224MT0H0N
3 to 1000	6.3	4	-55 to +125	-55 to +125	YFF18PC0J224MT0H9N
7 to 1000	16	4	-55 to +125	-55 to +125	YFF18PC1C104MT0H0N
7 to 1000	16	4	-55 to +125	-55 to +125	YFF18PC1C104MT0H9N

* The part numbers are TDK's standard specification products.

ELECTRICAL CHARACTERISTICS GRAPH

INSERTION LOSS VS. FREQUENCY CHARACTERISTICS

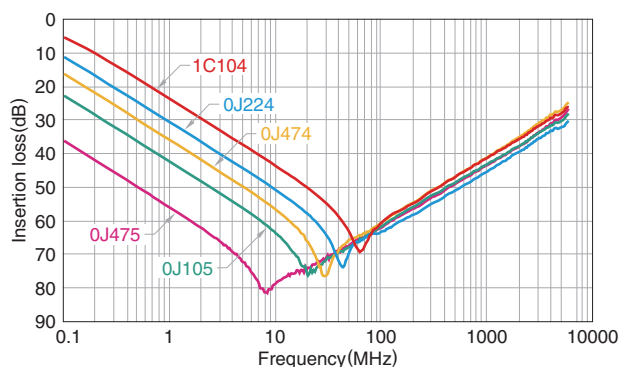

RATED CURRENT VS. TEMPERATURE CHARACTERISTICS (DERATING)

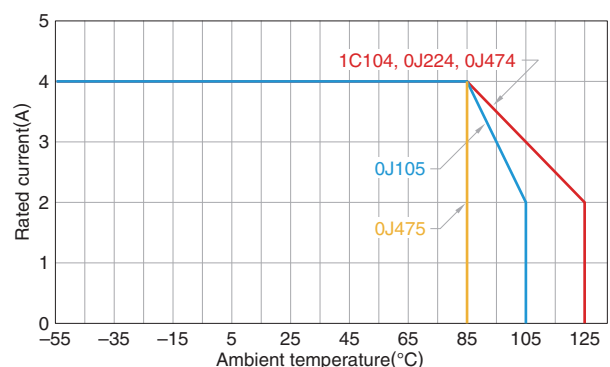

Please be sure to request delivery specifications that provide further details on the features and specifications of the products for proper and safe use.
Please note that the contents may change without any prior notice due to reasons such as upgrading.

YFF-P series YFF18PH type

SHAPE & DIMENSIONS

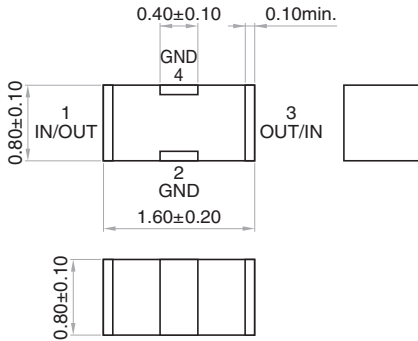

RECOMMENDED LAND PATTERN

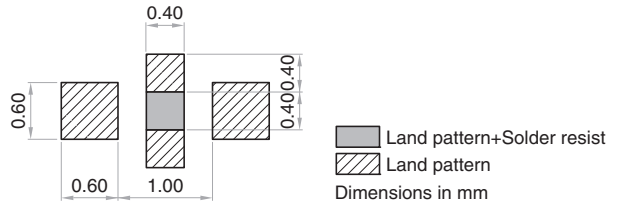

* Make sure to connect the GND terminal of this product and the GND of the mounting circuit board by using through holes so that the distance between them is the shortest.

ELECTRICAL CHARACTERISTICS

CHARACTERISTICS SPECIFICATION TABLE

Insertion loss 40dB frequency range (MHz)	Rated voltage Edc (V)	Rated current Idc (A)	Operating temperature range (°C)	Storage temperature range (After mount) (°C)	Part No.*
0.4 to 1000	6.3	4	-55 to +85	-55 to +85	YFF18PH0J225MT000N
0.4 to 1000	6.3	4	-55 to +85	-55 to +85	YFF18PH0J225MT009N
0.8 to 1000	6.3	4	-55 to +105	-55 to +105	YFF18PH0J105MT000N
0.8 to 1000	6.3	4	-55 to +105	-55 to +105	YFF18PH0J105MT009N

* The part numbers are TDK's standard specification products.

ELECTRICAL CHARACTERISTICS GRAPH

INSERTION LOSS VS. FREQUENCY CHARACTERISTICS

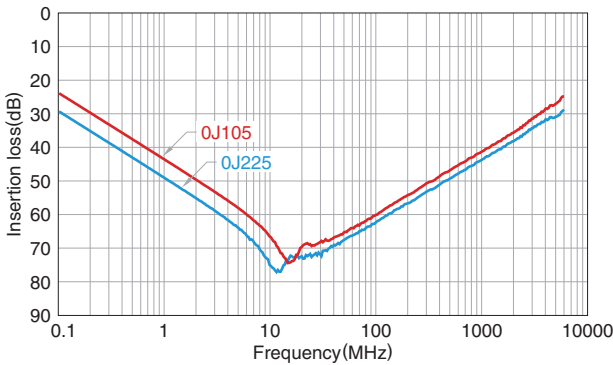

RATED CURRENT VS. TEMPERATURE CHARACTERISTICS (DERATING)

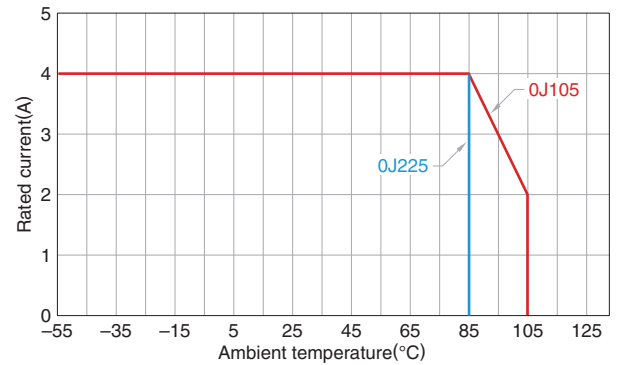

 Please be sure to request delivery specifications that provide further details on the features and specifications of the products for proper and safe use. Please note that the contents may change without any prior notice due to reasons such as upgrading.

YFF-P series YFF18PW type

SHAPE & DIMENSIONS

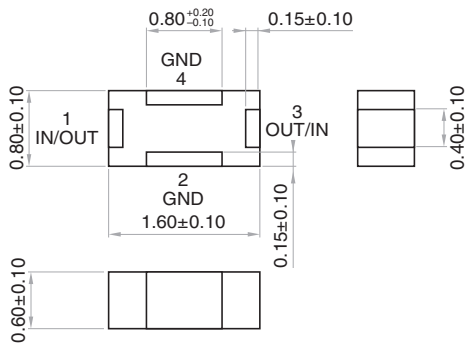

RECOMMENDED LAND PATTERN

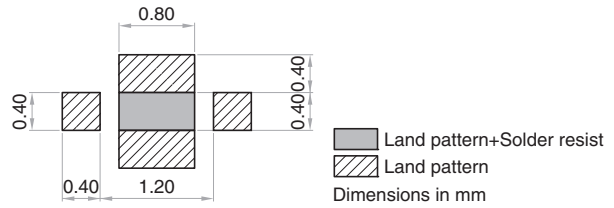

* Make sure to connect the GND terminal of this product and the GND of the mounting circuit board by using through holes so that the distance between them is the shortest.

ELECTRICAL CHARACTERISTICS

CHARACTERISTICS SPECIFICATION TABLE

Insertion loss 40dB frequency range (MHz)	Rated voltage Edc (V)	Rated current Idc (A)	Operating temperature range (°C)	Storage temperature range (After mount) (°C)	Part No.*
0.2 to 2000	6.3	4	-55 to +85	-55 to +85	YFF18PW0J475MT0H0N
0.2 to 2000	6.3	4	-55 to +85	-55 to +85	YFF18PW0J475MT0H9N
0.8 to 2000	6.3	4	-55 to +105	-55 to +105	YFF18PW0J105MT0H0N
0.8 to 2000	6.3	4	-55 to +105	-55 to +105	YFF18PW0J105MT0H9N
2 to 2000	6.3	4	-55 to +125	-55 to +125	YFF18PW0J474MT0H0N
2 to 2000	6.3	4	-55 to +125	-55 to +125	YFF18PW0J474MT0H9N

* The part numbers are TDK's standard specification products.

ELECTRICAL CHARACTERISTICS GRAPH

INSERTION LOSS VS. FREQUENCY CHARACTERISTICS

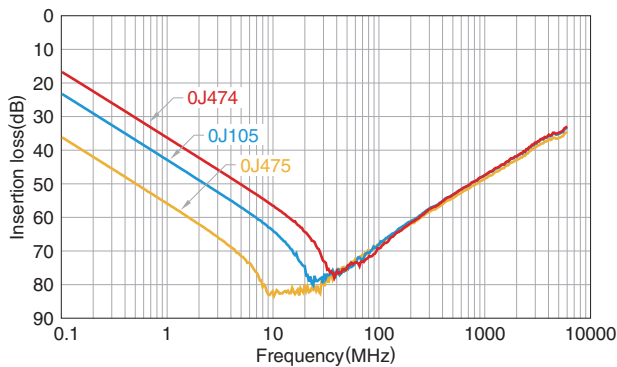

RATED CURRENT VS. TEMPERATURE CHARACTERISTICS (DERATING)

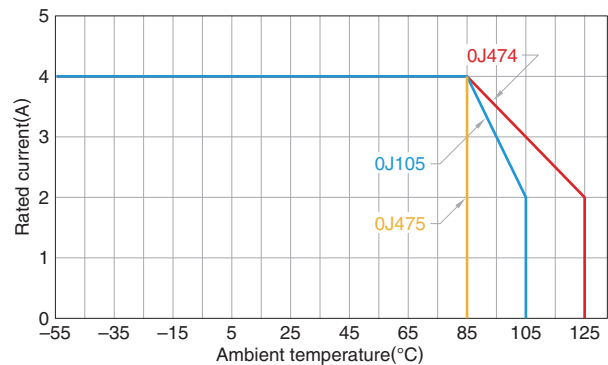

YFF-P series YFF21PC type

SHAPE & DIMENSIONS

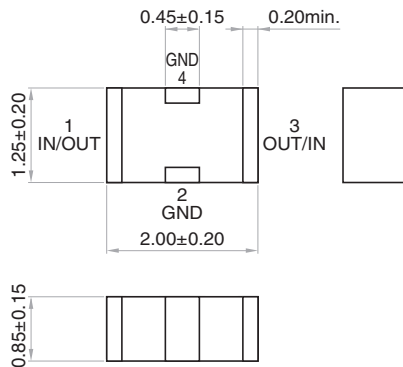

RECOMMENDED LAND PATTERN

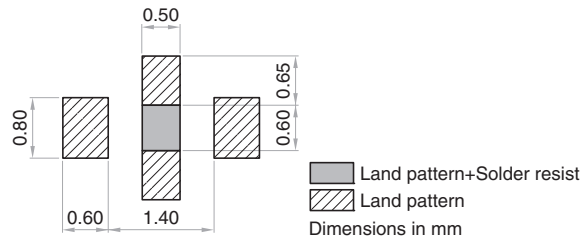

* Make sure to connect the GND terminal of this product and the GND of the mounting circuit board by using through holes so that the distance between them is the shortest.

ELECTRICAL CHARACTERISTICS

CHARACTERISTICS SPECIFICATION TABLE

Insertion loss 40dB frequency range (MHz)	Rated voltage Edc (V)	Rated current Idc (A)	Operating temperature range (°C)	Storage temperature range (After mount) (°C)	Part No.*
0.04 to 1000	6.3	4	-55 to +85	-55 to +85	YFF21PC0J226MT000N
0.04 to 1000	6.3	4	-55 to +85	-55 to +85	YFF21PC0J226MT009N
0.7 to 1000	10	4	-55 to +85	-55 to +85	YFF21PC1A105MT000N
0.7 to 1000	10	4	-55 to +85	-55 to +85	YFF21PC1A105MT009N
2 to 1000	16	2	-55 to +125	-55 to +125	YFF21PC1C474MT000N
2 to 1000	16	2	-55 to +125	-55 to +125	YFF21PC1C474MT009N
7 to 1000	25	2	-55 to +125	-55 to +125	YFF21PC1E104MT000N
7 to 1000	25	2	-55 to +125	-55 to +125	YFF21PC1E104MT009N

* The part numbers are TDK's standard specification products.

Background red: The product which is planning to stop production

ELECTRICAL CHARACTERISTICS GRAPH

INSERTION LOSS VS. FREQUENCY CHARACTERISTICS

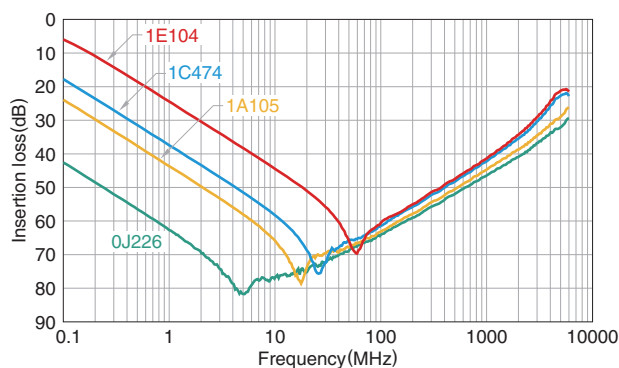

⚠ Please be sure to request delivery specifications that provide further details on the features and specifications of the products for proper and safe use.
Please note that the contents may change without any prior notice due to reasons such as upgrading.

YFF-P series YFF31PC type

SHAPE & DIMENSIONS

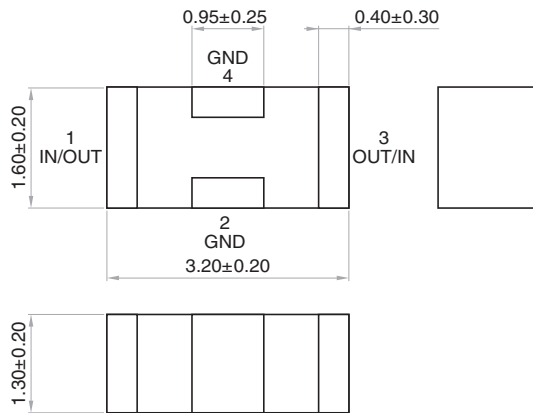

RECOMMENDED LAND PATTERN

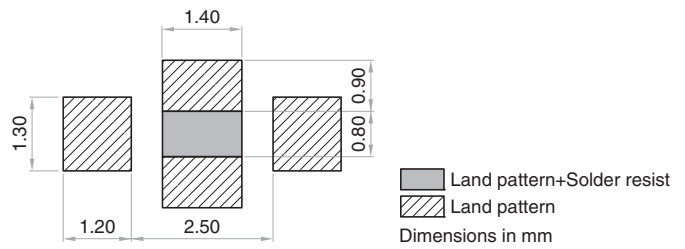

* Make sure to connect the GND terminal of this product and the GND of the mounting circuit board by using through holes so that the distance between them is the shortest.

ELECTRICAL CHARACTERISTICS

CHARACTERISTICS SPECIFICATION TABLE

Insertion loss 40dB frequency range (MHz)	Rated voltage Edc (V)	Rated current Idc (A)	Operating temperature range (°C)	Storage temperature range (After mount) (°C)	Part No.*
0.7 to 1000	16	2	-55 to +125	-55 to +125	YFF31PC1C105MT000N
0.7 to 1000	16	2	-55 to +125	-55 to +125	YFF31PC1C105MT009N
2 to 1000	16	2	-55 to +125	-55 to +125	YFF31PC1C474MT000N
2 to 1000	16	2	-55 to +125	-55 to +125	YFF31PC1C474MT009N
3 to 600	16	2	-55 to +125	-55 to +125	YFF31PC1C224MT000N
3 to 600	16	2	-55 to +125	-55 to +125	YFF31PC1C224MT009N
7 to 1000	16	2	-55 to +125	-55 to +125	YFF31PC1C104MT000N
7 to 1000	16	2	-55 to +125	-55 to +125	YFF31PC1C104MT009N

* The part numbers are TDK's standard specification products.

Background red: The product which is planning to stop production

ELECTRICAL CHARACTERISTICS GRAPH

INSERTION LOSS VS. FREQUENCY CHARACTERISTICS

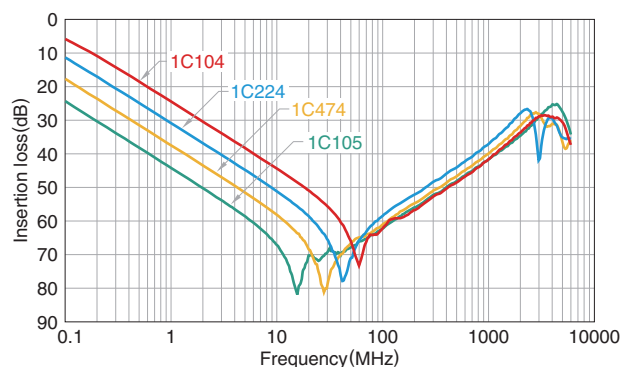

⚠ Please be sure to request delivery specifications that provide further details on the features and specifications of the products for proper and safe use.
 Please note that the contents may change without any prior notice due to reasons such as upgrading.

YFF-P series

Packaging style

REEL DIMENSIONS

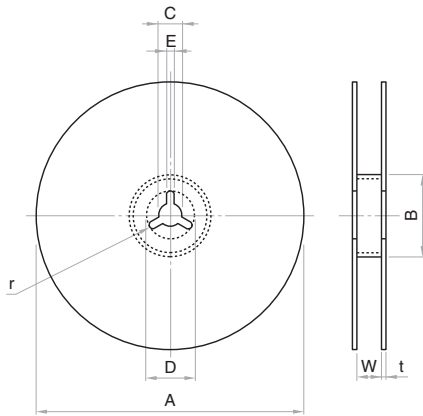

Dimensions in mm

Reel	A	B	C	D	E	W	t	r	Unit: mm
ø178	ø178±2.0	ø60±2.0	ø13±0.5	ø21±0.8	2.0±0.5	9.0±0.3	2.0±0.05	1.0	
ø330	ø382 max.(ø330 nom.)	ø50 min.	ø13±0.5	ø21±0.8	2.0±0.5	10.0±1.5	2.0±0.05	1.0	

TAPE DIMENSIONS

Paper tape

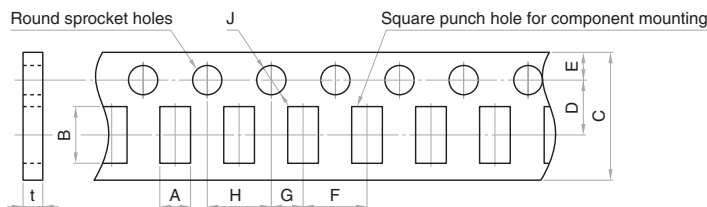

Type	A	B	C	D	E	F	G	H	J	t	Unit: mm
YFF15PC	0.62 typ.	1.12 typ.									
YFF15PC0G435M	0.75 typ.	1.18 typ.	8.00±0.30	3.50±0.05	1.75±0.10	2.00±0.05	2.00±0.05	4.00±0.10	ø1.5+0.1/-0	0.7 max.	
YFF15PC0G755M	0.75 typ.	1.30 typ.									
YFF15PC0G106M	0.77 typ.	1.30 typ.								0.8 max.	
YFF18PC											
YFF18PH	1.10 typ.	1.90 typ.	8.00±0.30	3.50±0.05	1.75±0.10	4.00±0.10	2.00±0.05	4.00±0.10	ø1.5+0.1/-0	1.2 max.	
YFF18PW											
YFF21PC	1.50 typ.	2.30 typ.	8.00±0.30	3.50±0.05	1.75±0.10	4.00±0.10	2.00±0.05	4.00±0.10	ø1.5+0.1/-0	1.2 max.	

Plastic tape

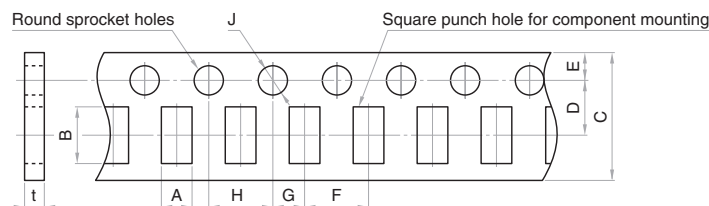

Type	A	B	C	D	E	F	G	H	J	K	t	Q	Unit: mm
YFF31PC	1.90 typ.	3.50 typ.	8.0±0.3	3.5±0.05	1.75±0.1	4.00±0.1	2.0±0.05	4.00±0.1	ø1.5+0.1/-0	2.50 max.	0.30 max.	ø0.50 max.	

⚠ Please be sure to request delivery specifications that provide further details on the features and specifications of the products for proper and safe use.
Please note that the contents may change without any prior notice due to reasons such as upgrading.